

Diamond X
EXCEPTIONAL MIRRORS. COLLECTION
FOR ELEGANT BATHROOMS.

From

www.illuminated-mirrors.uk.com

CE ROHS IP44



400mm Wide Illuminated Bathroom Cabinets with Sensor & Shaver Socket

(Model Numbers: 100877K68, K69 & K84)

Thank you for purchasing our illuminated mirror cabinet(s).

To avoid product damage, personal injuries, carefully read, understand, and follow all the Instructions in this installation guide before installing the product.

Save this manual for future reference.

CE ROHS IP44

WARNING!

To avoid the risk of electrocution, please turn off the electricity supply mains before commencing the installation.

CONTENT

I. STANDARDS

- a. Safety Instructions
- b. IP Rating
- c. Bathroom Zones

II. MIRROR CABINET PARTS

III. STEP-by-STEP INSTALLATION

Step 1: *Remove top mirror panel carefully with a screw driver.*

Step 2: *Remove LED strip / Fluorescent bulb to gain access to the fixing holes.*

Step 3: *Offer the cabinet up to the required position and Mark the holes on to the wall for drilling (Cabinet is heavy and we suggest 2 people for this job).*

Step 4: *Pull the 240volt connection cable through the rubber grommet on the back plate and Fix your mirror cabinet using the screws provided.*

Step 5: *Re-fix top mirror panel on to the cabinet using the adjuster screws on the rear of each panel to adjust height of each panel.*

Step 6 (If required):

Adjust hinges: In case of loosened mirror door and the hinge during the transit.

- a. *Sideways Positioning*
- b. *Inward Positioning*

Please note: *Cabinet door can only be adjusted when cabinet is fitted to the wall. Hinges will not adjust otherwise.*

Step 7: *Add glass shelves.*

Step 8: *Your cabinet is ready to use.*

IV. CARE AND CLEANING

V. FAQs

I. STANDARDS

a. Safety Instructions

- Installation of this product can require a qualified electrician. If necessary, hire or consult a qualified electrician in accordance with the current IEE Wiring Regulations and UK Building Regulations for assistance before continuing.
- Please turn off the electricity supply mains before commencing the installation.
- This light fitting is a class I product and therefore must be earthed.
- Always use the correct type and wattage bulb; never exceed the stated/rated wattage as this could overheat the transformer.

b. IP rating

The **IP Code** (or **Ingress Protection Rating**, sometimes also interpreted as **International Protection Rating**) consists of the letters IP followed by two digits or one digit and one letter and an optional letter. These two digit numbers refer to the level of protection the product has and it is important that you choose fittings with correct ratings according to where they are installed within the bathroom.

c. Bathroom Zones

Our illuminated mirror cabinet has special protection against the ingress of moisture and is manufactured to meet IP44 standard, thereby making it suitable for use in Zones 2 and 3 of a bathroom with reference to the below diagram.

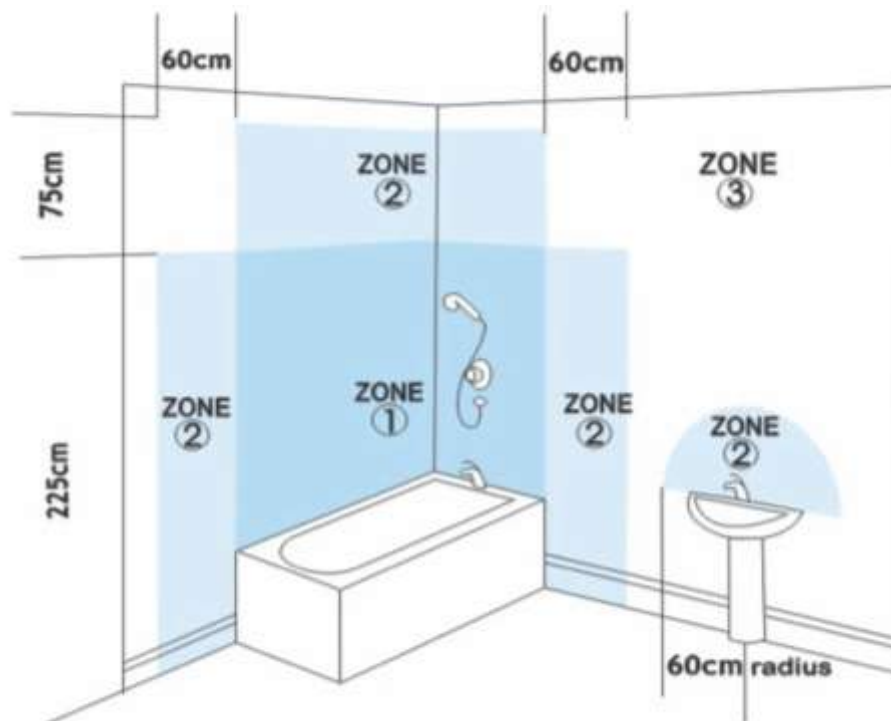

II. CABINET PARTS

(Figure i) – Cabinet with closed door.

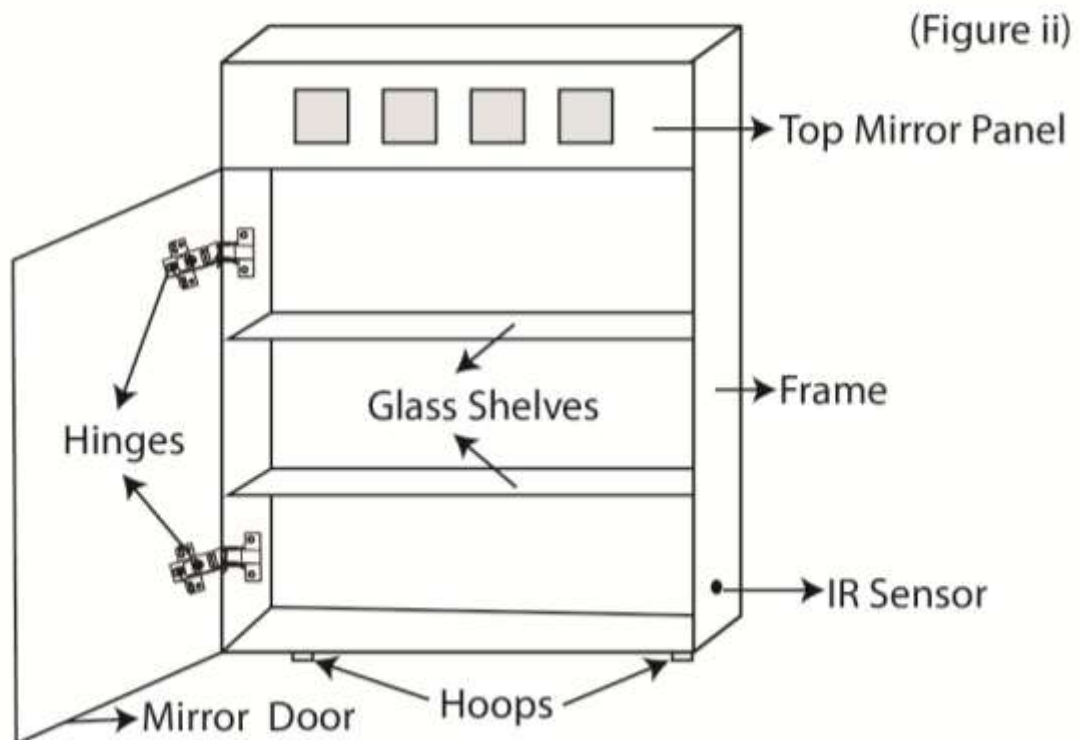
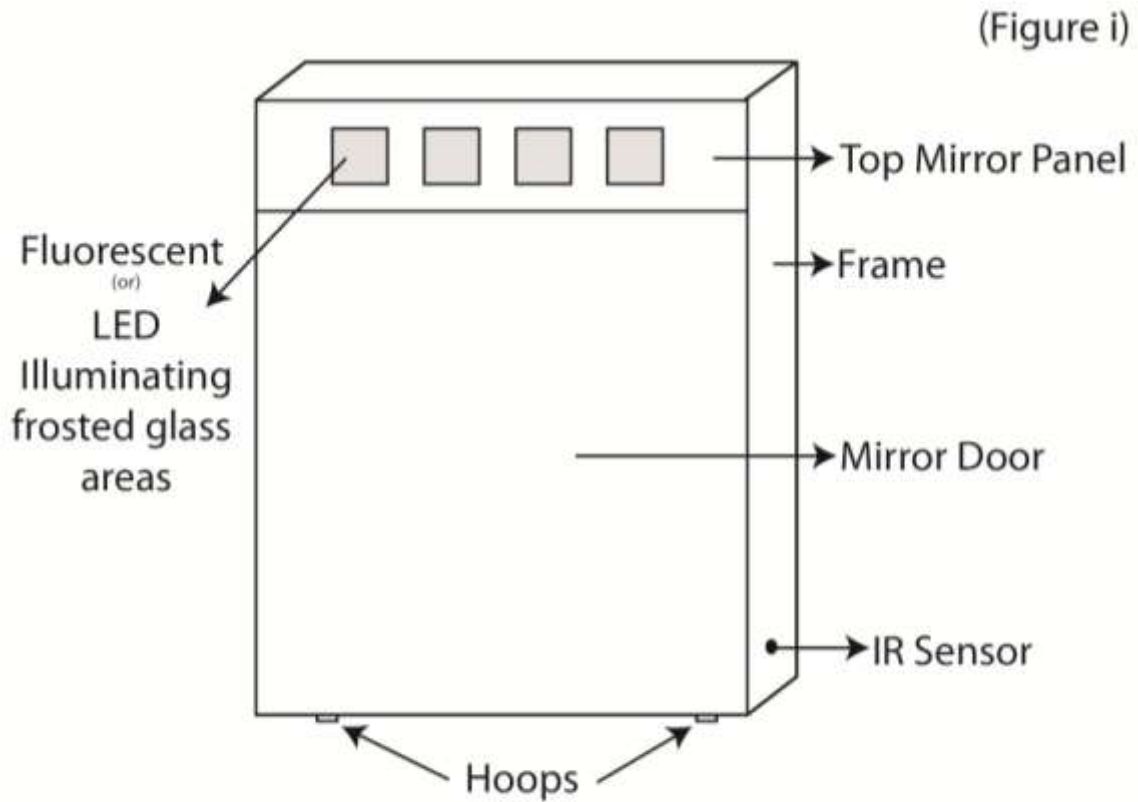

(Figure ii) – Cabinet with open door.

III. INSTALLATION

- Please turn off the electricity supply mains before commencing the installation.

- **Wiring Colours:**

Earth (E) **GREEN**

Neutral (N) **BLUE**

Live (L) **BROWN**

Step 1:

- Remove top mirror panel with a screw driver.

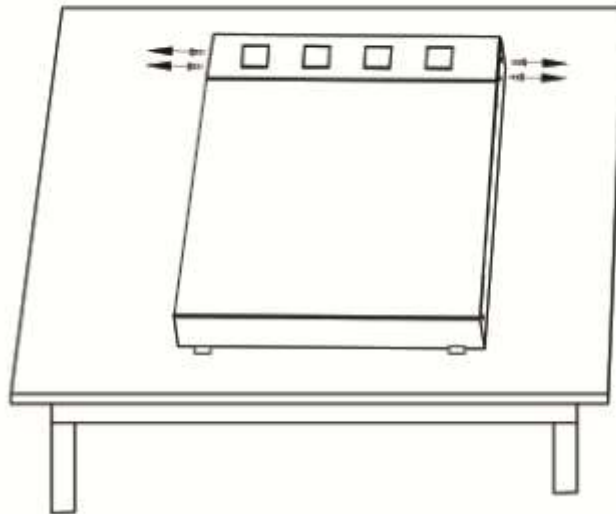

Step 2:

- Remove LED strip / Fluorescent bulb to gain access to the fixing holes.

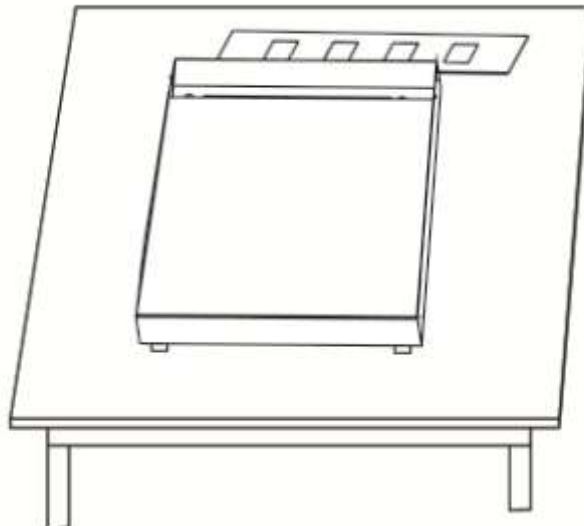

Step 3:

- Offer cabinet up to required fixing position and mark the holes for drilling using a pencil.

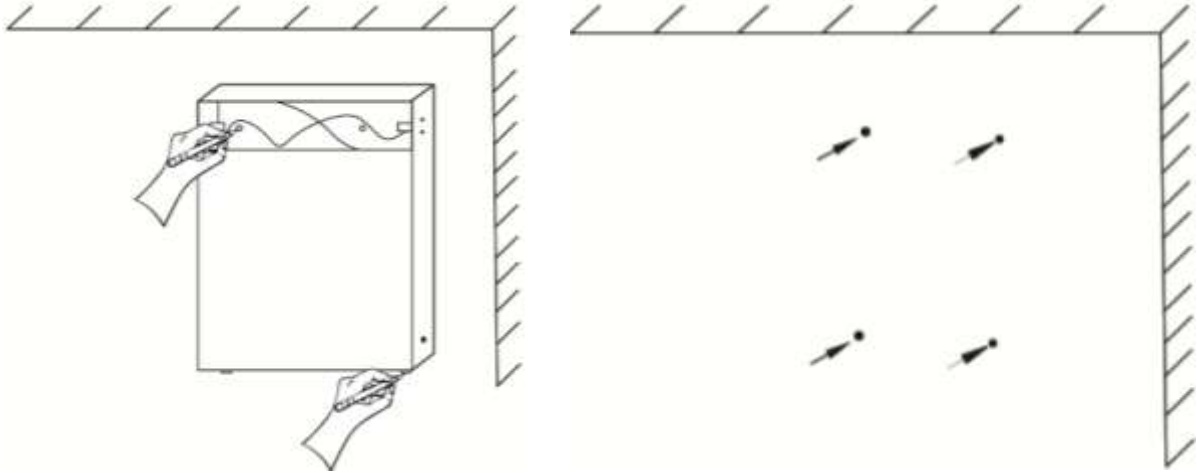
**Step 4:**

- Pull the 240 Volt connections through the back plate.
- And fix the cabinet to the wall.

Note: Cabinet is heavy and we suggest 2 people for this job.

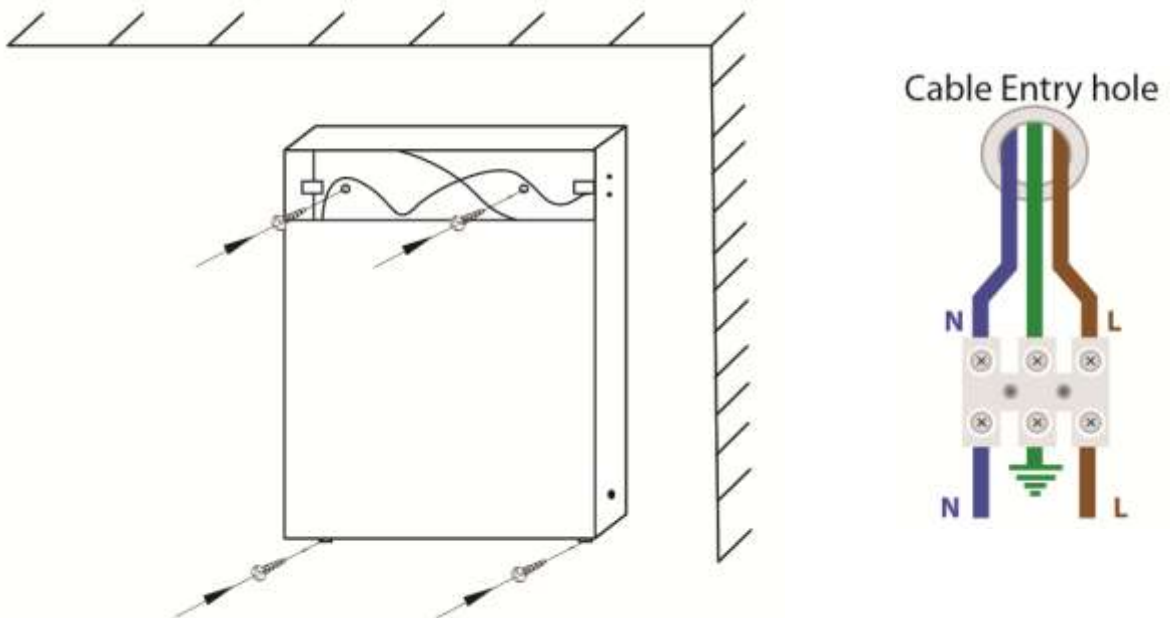

Step 5:

- Refix top mirror panel on to the cabinet.

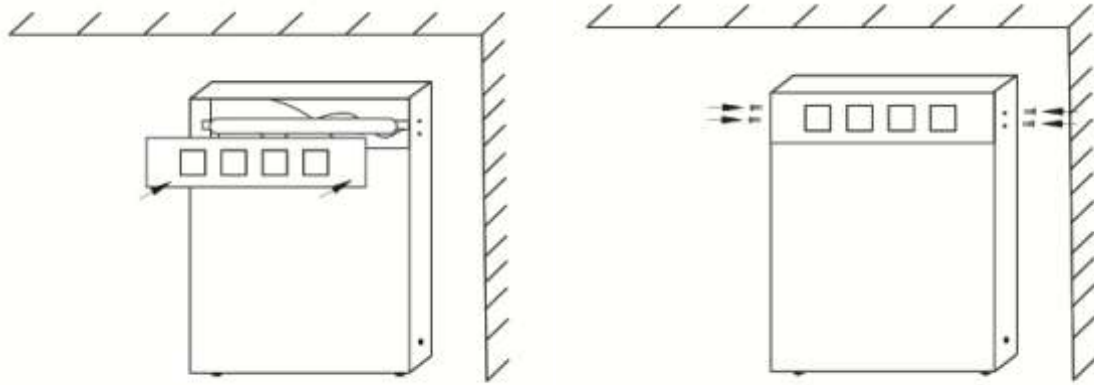
**Step 6 (If required):**

In case of loosened mirror door and the hinge during the transport, please adjust hinge and mirror door using a screw driver with the following illustrating diagrams.

Please note cabinet door can only be adjusted when cabinet is fitted to the wall. Hinges will not adjust otherwise.

(a) Sideways Positioning

- Using a screw driver loosen the **Screw.1** in anti-clockwise direction as shown in the below diagram.

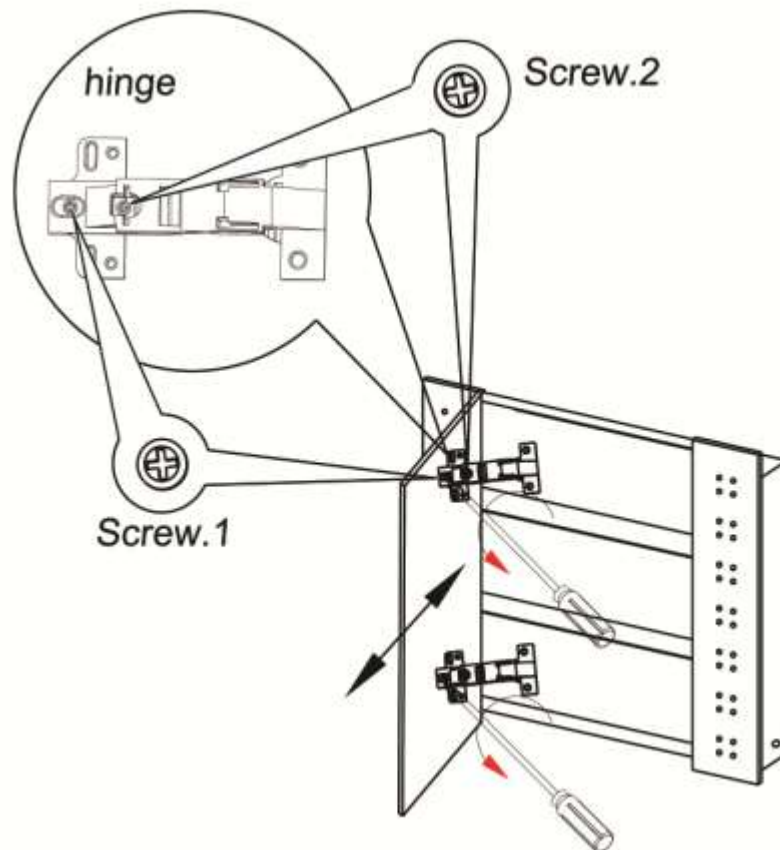

- After loosening **Screw.1**, please move the mirror door to the left or to the right, and make sure the mirror door is in the middle between two side mirror panels as show in the below diagram.

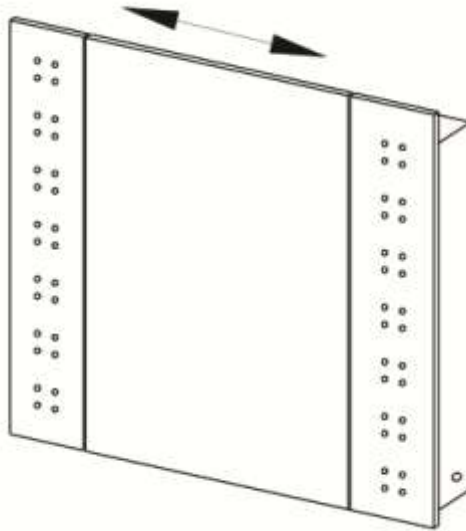

- After making sure that the mirror door is in the middle between two side mirror panels, please tighten the **Screw.1** in clock-wise direction with the help of a screw driver, as shown below.

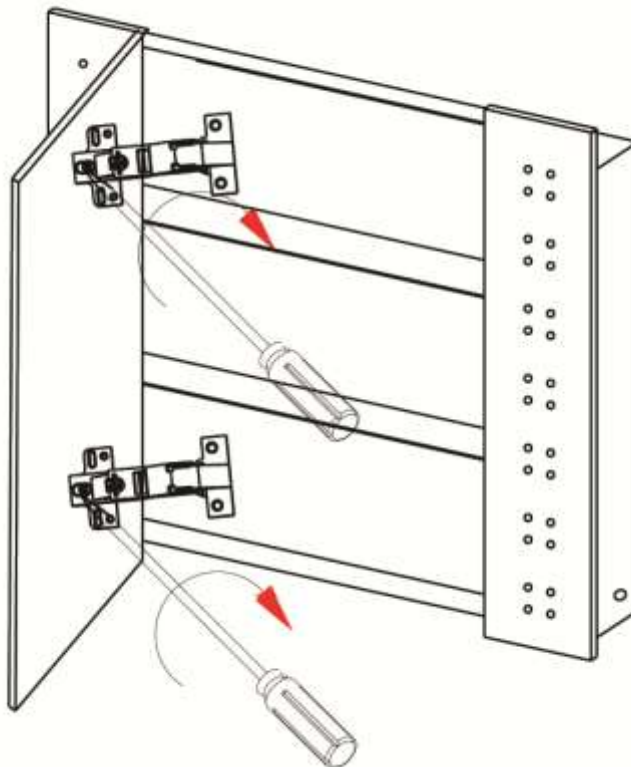

(b) Inward Positioning

- Using a screw driver rotate **Screw.2** to the left or to the right hand side, as shown below.

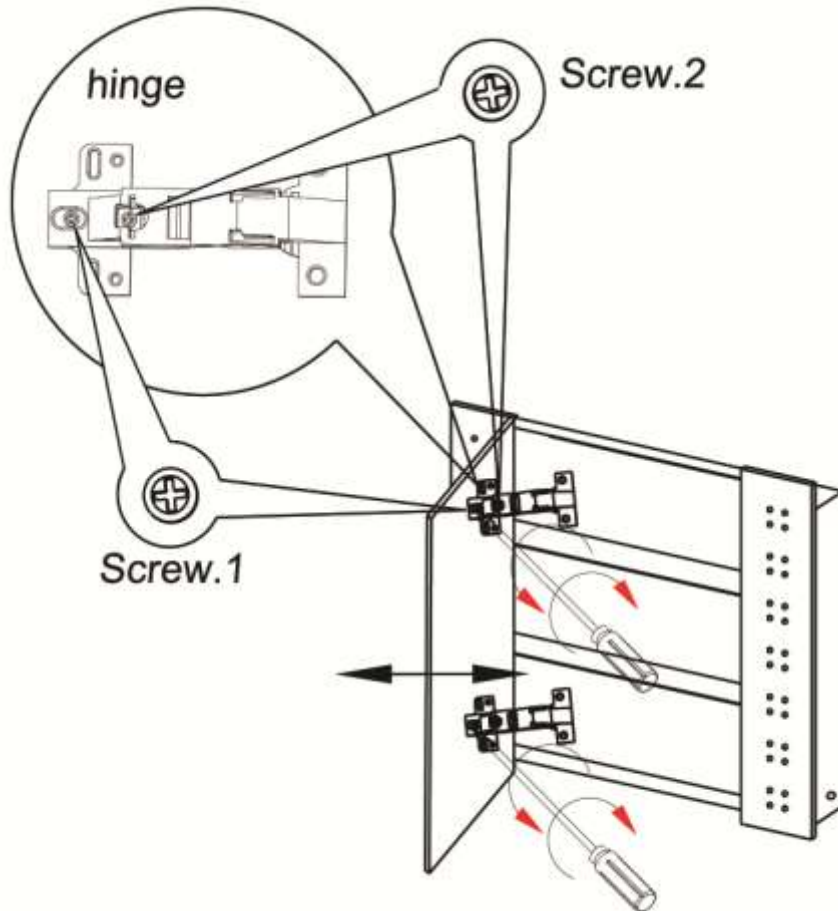

- Mirror door will be moved inwards or outwards from the cabinet by adjusting **Screw.2** towards the left-hand side or right-hand side respectively, as shown below.

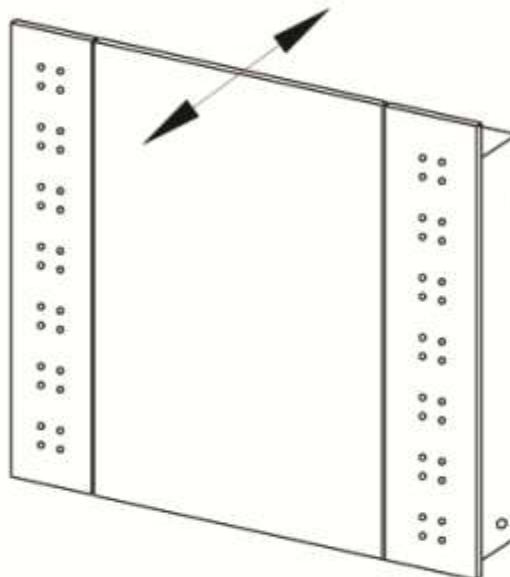

Step 7:

Add glass shelves.

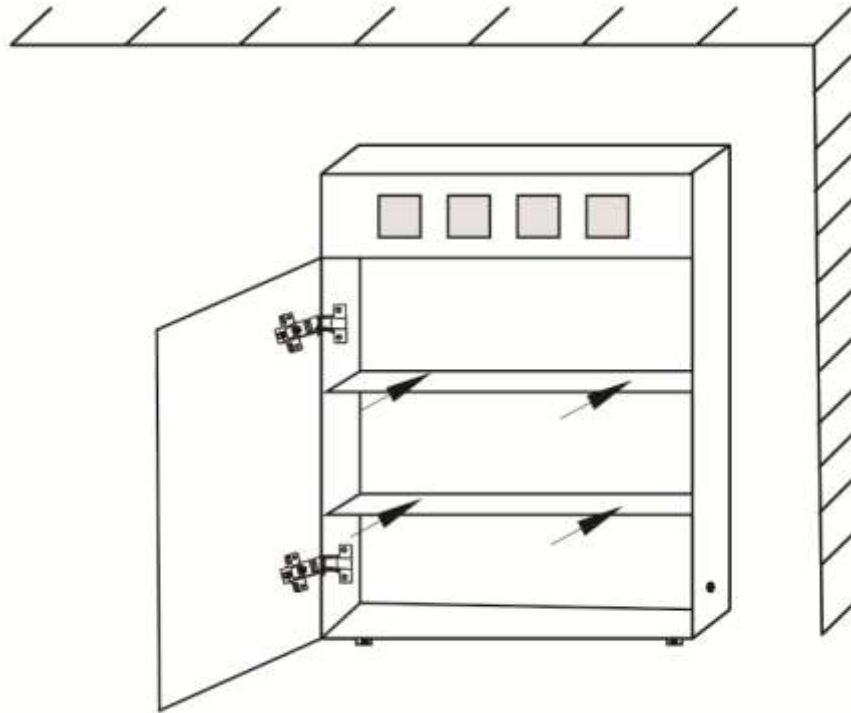

Step 8:

And your cabinet is ready to use!

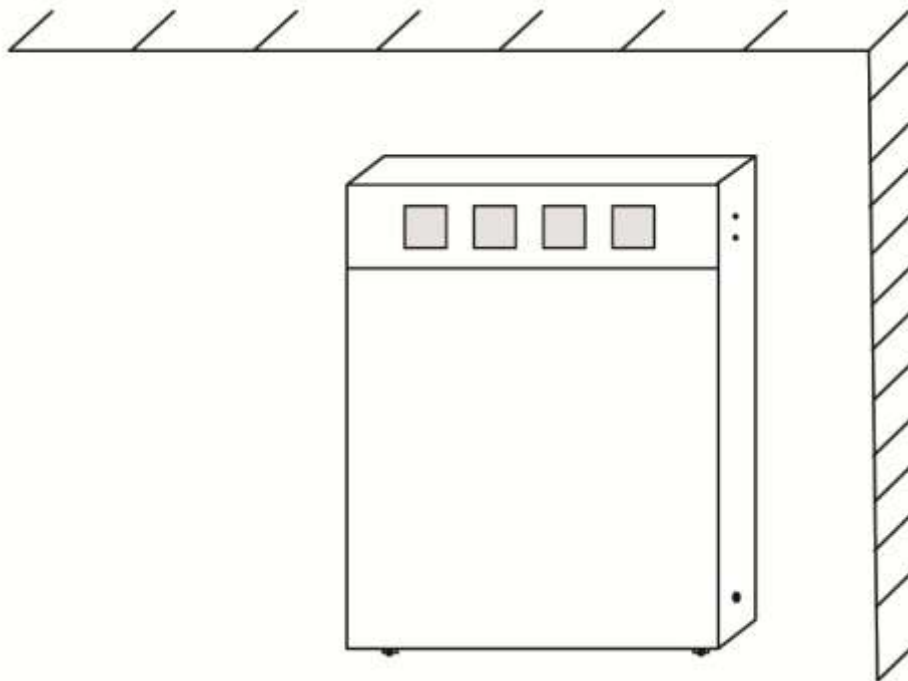

IV. CARE AND CLEANING

- Please be aware when cleaning the mirror surface, do not to use abrasive materials as these will damage the overall finish.

V. FAQs

1. What is a LED Mirror?

A LED Mirror uses Energy Saving LED light bulbs. They are Waterproof Rated IP44 for use in bathrooms and include clever technology like, Infra-Red on/off sensors, Anti-Mist demister pads and a shaver socket.

2. On/Off Infra-Red Sensor?

All our LED Mirrors include Infra-Red on/off Sensor, simply wave your hand to the sensor and it will instantly powers up the lights and demister pad. You need to wave your hand 3-6 inches away to On/Off your mirror cabinet.

3. Where is the sensor located?

The sensor is located on the bottom right of the frame and not on the front of the glass.

4. Can I isolate the sensor so the led's come on with my bathroom lighting?

Yes, Just call us for instructions and we shall email them to you, it's extremely easy!

5. How the Shaver Socket Works?

Shaver Mirrors include a 240 Volt shaver socket for the use of electric shavers and toothbrushes. The shaver socket includes its own on/off rocker switch which works separately from the lights and demister pad.

6. Heated Demister Pad Mirrors?

Just turn on the lights via Infra-Red sensor and the heat pad removes the steam from the glass on the door.

7. How do I activate the demister pad?

The demister pad works automatically when the lights are turned on and off.

8. Is the mirror tinted glass?

No, the mirror is perfectly clear reflective mirror glass.

9. Is the mirror CE & ROHS certified?

Yes!
